

LinTronic

<http://www.lintronic.dk>

TT-IR-ET03 3-way low power InfraRed emitter

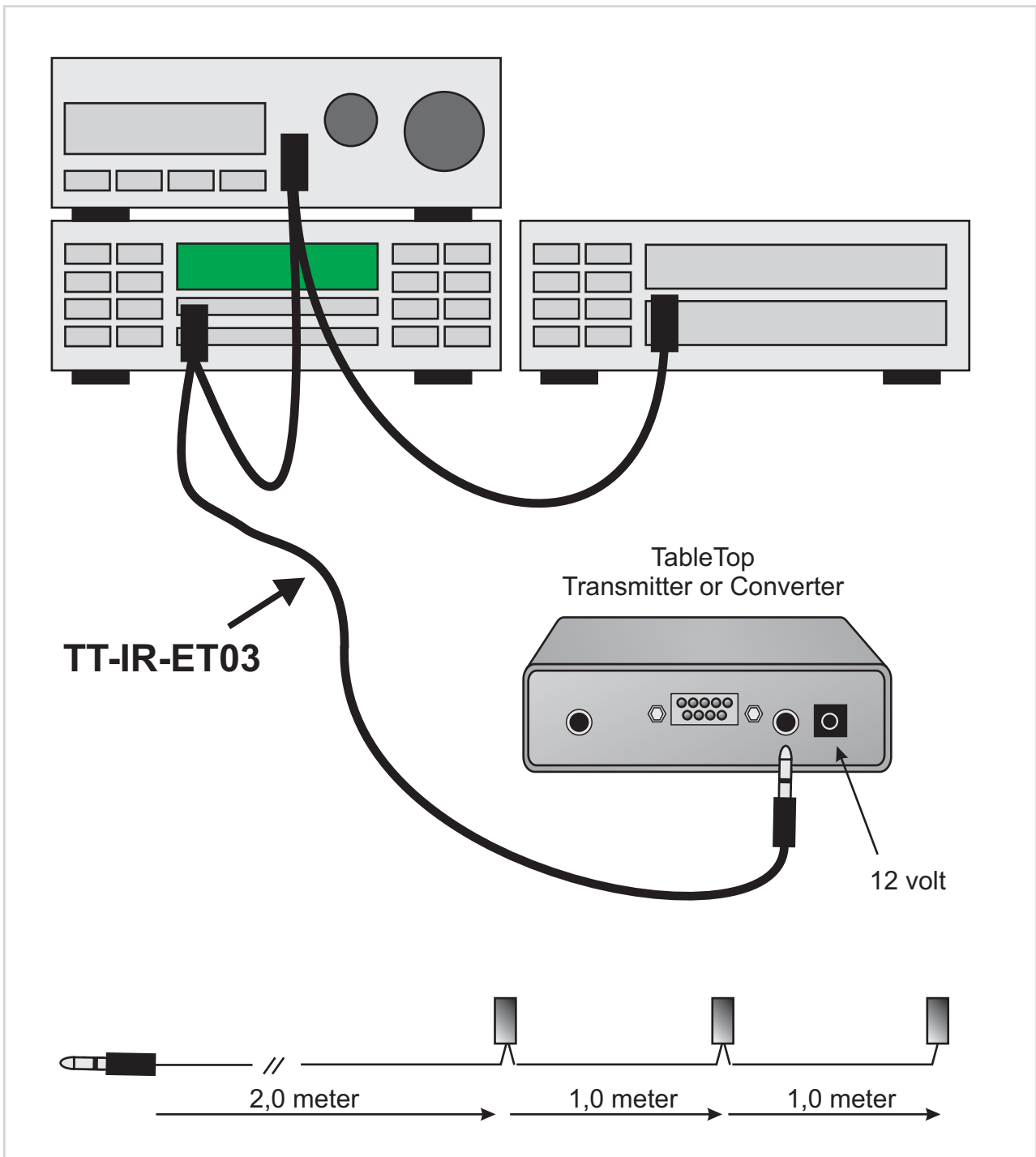

LinTronic

<http://www.lintronic.dk>

TT-IR-Distributor If you need more than one TT-IR-ET03

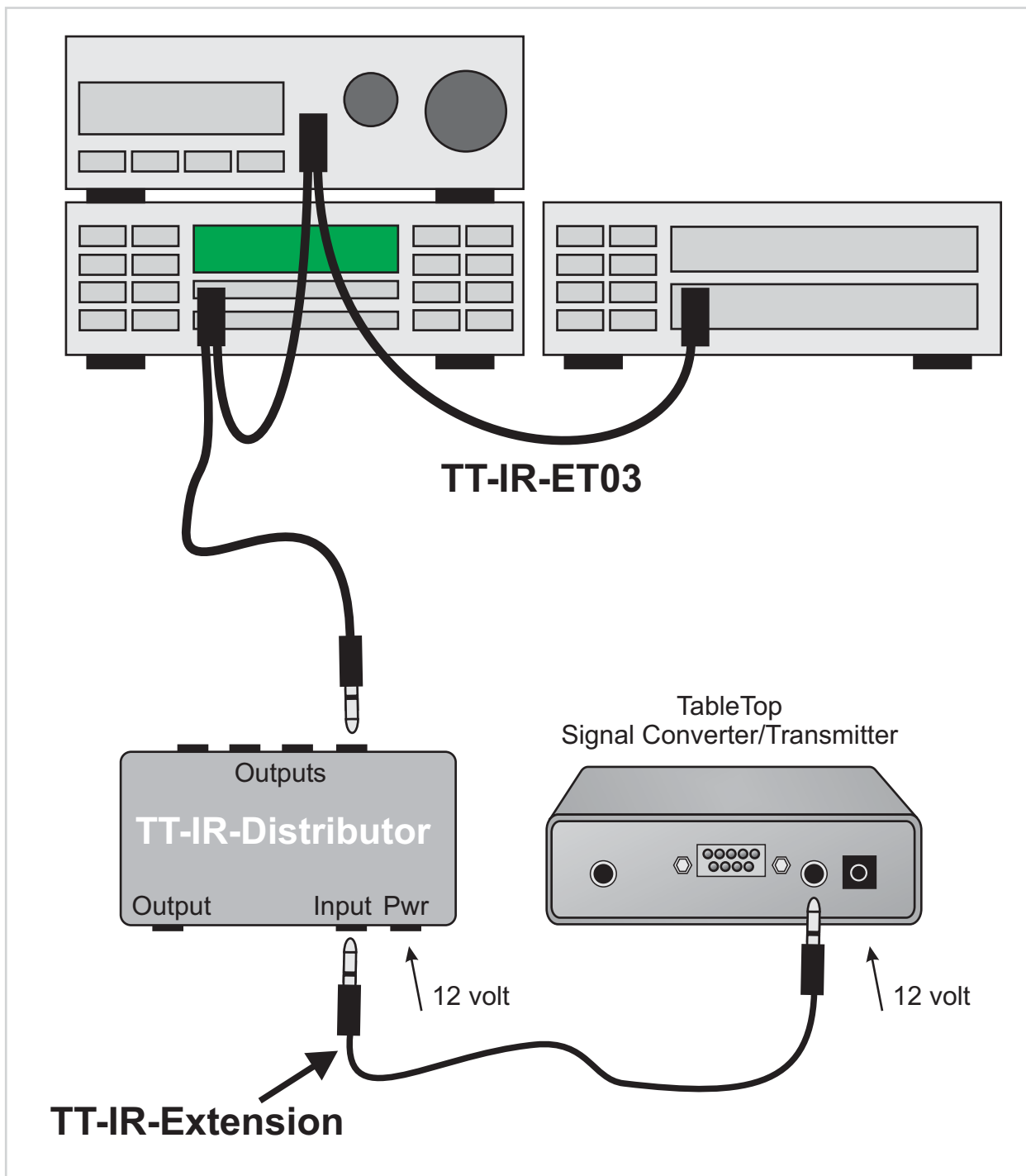

LinTronic

<http://www.lintronic.dk>

TT-IR-Distributor supports up to 5 TT-IR-ET03's

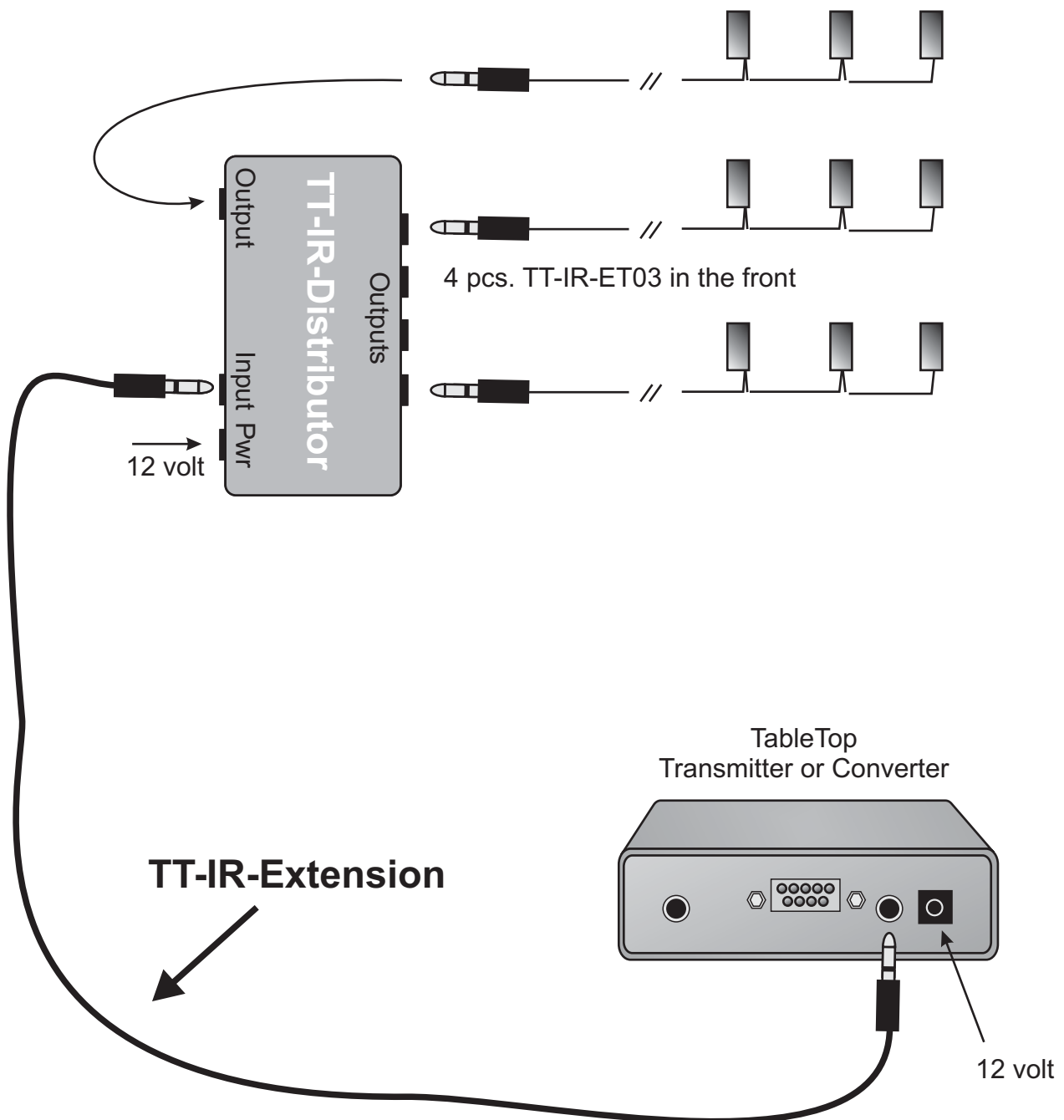

LinTronic

<http://www.lintronic.dk>

TT-IR-Distributor Cascade connecting

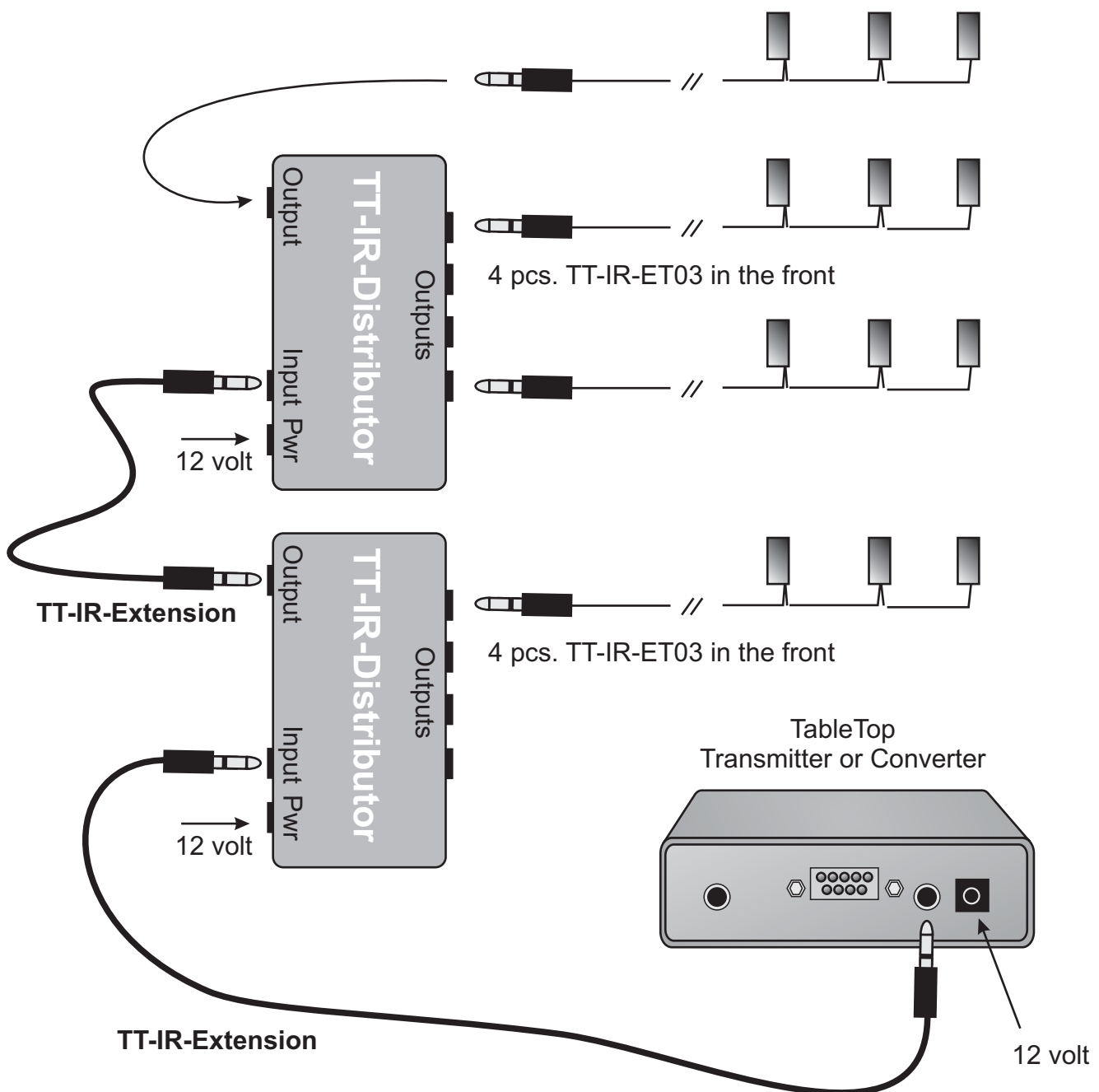

LinTronic

<http://www.lintronic.dk>

TT-IR-Distributor



Front view
4 outputs

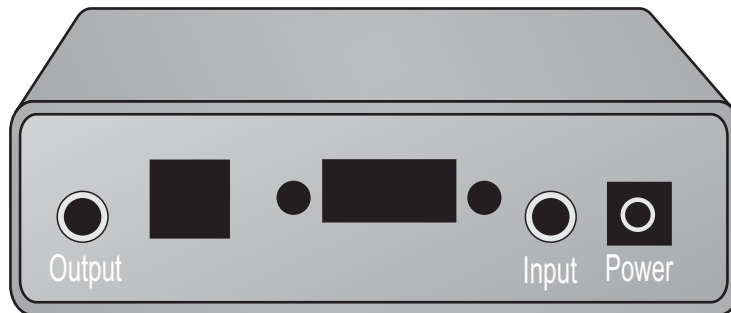

Rear view

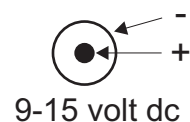

Front view, Outputs, 3.5 mm jack connector

These outputs deliver a current limited signal, intended to drive low-power IR emitters.

Rear view, Outputs (Extension), 3.5 mm jack connector

This output can be connected to the next TT-IR-Distributor's Input, allowing you to cascade connect an unlimited number of TT-IR-Distributor's.

Rear view, Input, 3.5 mm jack connector

The input receives low-power infrared signals from the TableTop product. The signal is then amplified and distributed to the front outputs and the rear output.

Power

Accepts power supply in the range 9-18 volt dc.

A power supply capable of delivering 150 - 300 mA is sufficient.

LinTronic

<http://www.lintronic.dk>

TT-IR-Distributor

Hardware Version 2

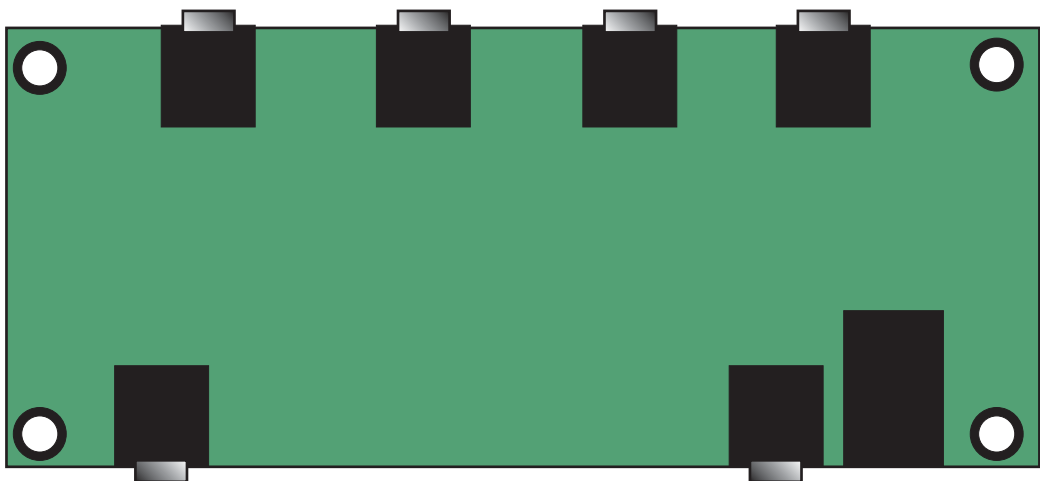

Hardware Version 1

